

23117-536

Canon

Speedlite

430EZ



- \* **E** Instructions - English Edition
- \* **F** Mode d'emploi - Français
- \* **S** Instrucciones - Edición Española

<b>Técnicas Avanzadas de Tomas Fotográficas</b> .....	48
Ajuste de compensación de Exposición (únicamente para EOS-1 y 630) .....	50
Tomas Fotográficas con Flash Manual .....	52
Flash Estroboscópico .....	56
Fotografía con Flash de Rebote .....	62
Fotografía de Flash con Sincronización a la Segunda Cortinilla .....	66
Fuente de Alimentación Externa .....	70
Fotografías con el Flash Fuera de la Cámara .....	72
<b>Datos Técnicos</b> .....	76

## Table of Contents

Nomenclature .....	4, 5	Stroboscopic Flash .....	57
Introduction .....	7	Bounce Flash-Photography	63
<i>Handling Precautions</i> .....	11	Second-Curtain Sync Photography .....	67
<b>Preliminary Preparations</b> ..	13	External Power Supply .....	71
Loading the Batteries .....	13	Off-Camera Flash Photography .....	73
Mounting the Flash .....	17	<b>Specifications</b> .....	77
Ready Lamp and Test Firing .....	17		
SE (Save Energy) Function .....	21		
Auto Internal Zoom Mechanism .....	23		
Film Speed Setting .....	25		
Display Panel Illumination ..	25		
AF Auxiliary Light .....	25		
<b>Basic Operation</b> .....	27		
Flash Photos in Bright Setting .....	31		
<b>Other Operations</b> .....	33		
Shutter-Priority (TV) Shooting	33		
Aperture-Priority (AV) Shooting .....	39		
Manual Mode .....	45		
<b>Advanced Shooting Techniques</b> .....	49		
Fill-in Ratio Control (EOS 1 and 630 only) ....	51		
Manual Flash Shooting .....	53		

**ENGLISH-TEXT  
PAGES ONLY**

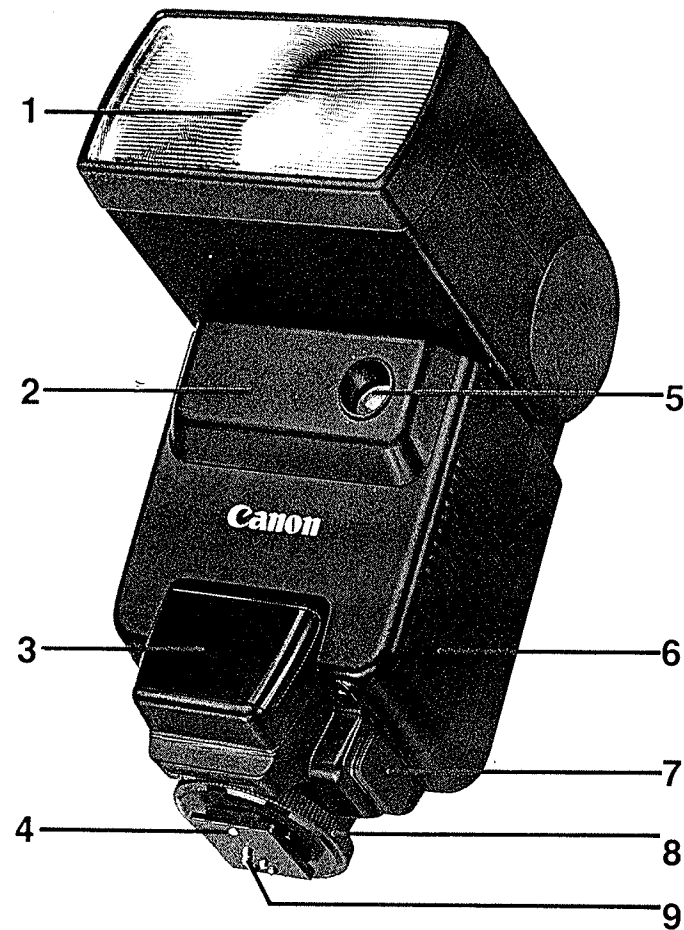

4

## Nomenclature

1. Flash Head
2. Infrared Light Emitter
3. AF Auxiliary Light Emitter
4. Lock Pin (EOS-1, 630 only)
5. Sensor
6. Battery Chamber
7. External Battery Pack Socket
8. Lock Nut
9. Directly Coupled Contact

## Nomenclature

1. Tête du flash
2. Emetteur de rayon infrarouge
3. Emetteur de rayon auxiliaire autofocus
4. Griffes de verrouillage (EOS-1, 630 uniquement)
5. Capteur
6. Logement des piles
7. Prise pour bloc d'alimentation
8. Molette de verrouillage
9. Contact direct

## Nomenclatura

1. Cabezal del Flash
2. Emisor de Luz Infrarroja
3. Emisor de Luz Auxiliar AF
4. Pin de Fijación (EOS-1, 630 únicamente)
5. Sensor
6. Cámara de las Pilas
7. Enchufe para Paquete de Pilas Externas
8. Contratuerca
9. Contacto Directo

## Introduction

debido a que el ajuste se memoriza aun cuando se desactive el interruptor principal.

Lectura del Folleto de Instrucciones

Este folleto se divide en tres secciones.

Si Ud. desea sacar fotografías inmediatamente, lea la sección Operación Básica. Para una explicación sobre los ajustes del valor de obturación y abertura, lea la sección Otras Operaciones. Para mayores detalles sobre procedimientos más avanzados, lea la sección Técnicas Avanzadas de Tomas Fotográficas.

- Para identificar fácilmente las partes componentes del Speedlite, desdoble las solapas delantera y trasera de este folleto. ①

Especially designed for EOS cameras, the Canon Speedlite 430EZ is a high-performance, electronic flash. It features automatic flash output which responds to a wide range of illumination from dark surroundings to bright (fill-flash) without troublesome operations. Advanced techniques such as bounce and slow-sync flash photography can be used in the automatic mode.

There are also two types of external power sources which can be used. The recharge time has been reduced considerably to increase shooting opportunities.

When used with the EOS-1, the flash characteristics include the display of the aperture value and distance in 1/3 steps for each level,

and complete interface with all camera operations. In addition, the flash mode doesn't need to be reset each time because the setting is memorized even if the main switch is set to OFF.

Reading this Instruction Booklet.

This booklet is divided into three sections.

Read the *Full Automatic* section if you wish to take pictures right away. Read the *Other Operations* section for an explanation of the shutter/aperture value settings. Read the *Advanced Shooting Techniques* section for further details about more advanced procedures.

- For easy reference to the Speedlite's parts, please unfold the front and back flaps of this booklet. ①

①

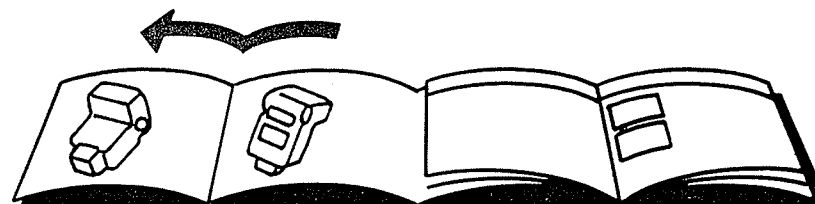

## **INFORMACION IMPORTANTE**

El Canon Speedlite 430EZ brindará un rendimiento óptimo junto con las cámaras Canon EOS, objetivos EF y otros accesorios especialmente diseñados de marca Canon. Es posible que el empleo de objetivos incompatibles u otros accesorios tenga como resultado un rendimiento poco satisfactorio o que estropee su Canon Speedlite 430EZ. Por lo tanto le sugerimos la utilización de cámaras EOS, objetivos y accesorios Canon. El daño que su Canon Speedlite 430EZ pueda sufrir como resultado de un funcionamiento defectuoso o por conexiones inadecuadas a causa de la utilización de productos incompatibles, puede invalidar la garantía del mismo.

The Canon Speedlite 430EZ uses Advanced TTL (ATTL) automatic flash control. This function provides the appropriate flash control for the background as well as the subject, for conditions ranging from total darkness to fill-in flash.

- In continuous flash shooting in servo or AI servo AF mode, the exposure is set at the first frame.
- The EOS 630 is sold under the name of the EOS 600 in Europe.

## **IMPORTANT INFORMATION**

The Canon Speedlite 430EZ will give optimum performance together with specially designed Canon EOS cameras, EF lenses and other Canon brand accessories. It is possible that the use of incompatible lenses or other accessories may result in unsatisfactory performance or damage to your Canon Speedlite 430EZ. We therefore suggest the use of Canon EOS bodies, lenses and accessories. Damage to your Canon Speedlite 430EZ, as a result of malfunction of improper connections caused by the use of incompatible products may void its warranty.

## Manejo

- miento defectuoso imprevisto, o estropearse.
5. Cuando se almacene la unidad durante algún tiempo, efectúe algunos destellos de prueba de vez en cuando, para mantener la operación correcta del condensador.
  6. Saque las pilas si no va a utilizar el flash por un período de tres semanas o más. Las pilas pueden tener fugas de ácido y destruir su unidad de flash.
  7. Si el flash no carga, aun después de haber colocado pilas nuevas, pruebe limpiar los contactos para pilas de la unidad de flash con una goma de borrar y luego finalice la limpieza utilizando un paño suave o un pañuelo de papel.

8. **Nunca levante el flash estando la cámara acoplada. La base del flash no ha sido diseñada para soportar el peso de una cámara y un objetivo.**

## Handling Precautions

1. Do not take the flash unit apart. Several hundred volts are stored in a fully charged capacitor. If repair is necessary, take it to the nearest Canon Service Facility.
2. Do not get the flash wet. If exposed to rain or snow, immediately wipe it off with a clean, dry cloth.
3. Do not store the flash in hot or humid places such as in the trunk or rear window of a car. Keep it out of direct sunlight.
4. Do not use the 430EZ with any other manufacturer's cameras because the 430EZ is especially designed for use with Canon EOS cameras. If it is used with another manufacturer's camera, it may cause unanticipated malfunction or damage.
5. When storing for a while, test fire the unit from time to time to maintain proper capacitor functioning.
6. Remove the batteries if you do not expect to use the flash about three weeks or longer. Batteries can leak acid destroying your flash unit.
7. If the flash does not charge up, even after installing new batteries, try cleaning the battery contacts in the flash unit with a pencil eraser then wipe them clean with a soft cloth or tissue.
8. **Never pick up the flash with the camera attached. The base of the flash was never designed to support the weight of a camera body and lens.**

## Preliminary Preparations

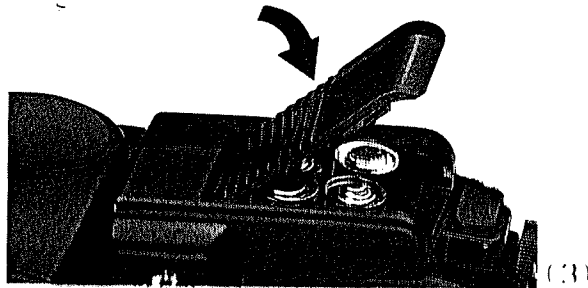
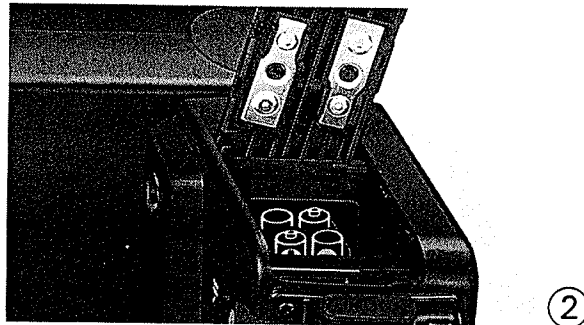
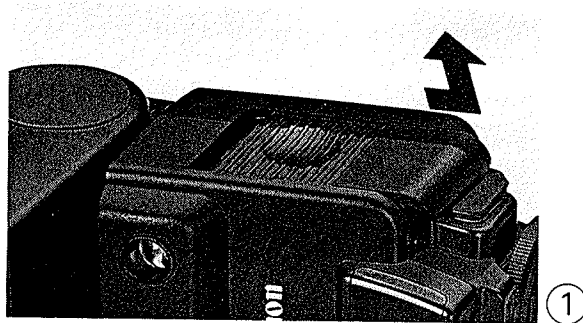

### Loading the Batteries

1. Slide the battery chamber cover toward the lock nut to open it. The cover cannot be removed. ①
2. Load the batteries so that their terminals face in the directions indicated by the diagram inside the battery chamber. ②
3. Push the cover all the way down and slide it back to close it. ③

When shooting is completed, always turn the main switch OFF (“O” mark).

## Batteries

- Use four new, size-AA alkaline (LR6) batteries. When the batteries are dead, replace them all at the same time with the same brand.
- When using Ni-Cd batteries, please note that various brands have different types of terminals. Be sure to use a suitable type. Recharge Ni-Cd batteries according to the manufacturer's instructions. Carbon-zinc batteries may also be used, but their life is shorter.
- **Remove the batteries if you do not expect to use the flash unit for about three weeks or longer.**
- Battery performance deteriorates in cold temperatures below 0°C/32°F. Keep the batteries warm until just before use. For best results, use fully-charged Ni-Cd batteries in cold temperatures below 0°/32°F.
- Wipe the battery terminals with a clean, dry cloth to ensure proper contact because correct electrical contact is not possible if the contact surface is dirty. (See handling precautions # 7)



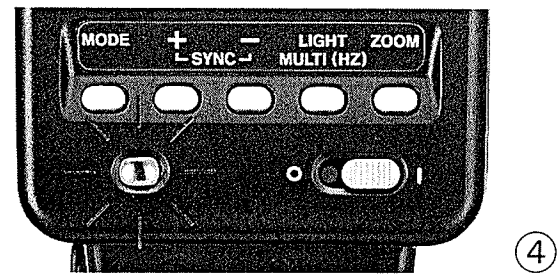
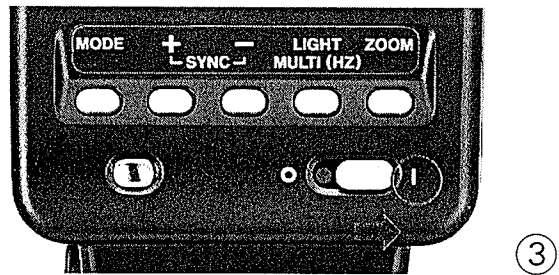
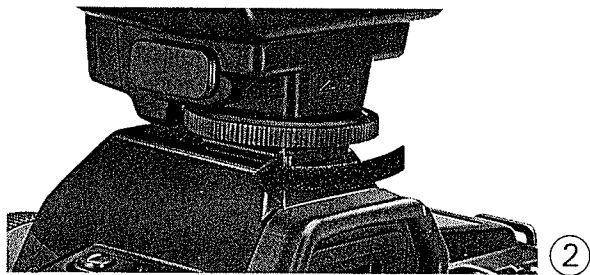
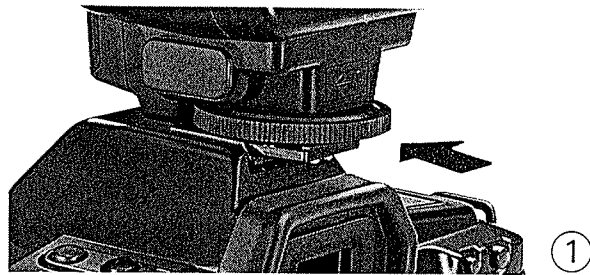

## Mounting the Flash

1. Loosen the lock nut and slide the flash unit into the camera's accessory shoe. To ensure correct electrical contact, make sure it is pushed in all the way. ①
2. Tighten the lock nut by turning it clockwise. ②

The EOS-1 and 630 have a tiny hole on the accessory shoe. This hole requires that the flash be *securely* fastened for proper operation.

## Ready Lamp and Test Firing

1. When the main switch is turned ON ("I" mark) the flash begins charging. Charging is completed when the ready lamp glows. The "⚡" mark in the viewfinder also glows when the shutter button is pressed halfway. ③
2. To test fire the flash, press the ready lamp after it glows. The flash fires when it is in proper working order. ④
  - Test fire the flash *before* pressing the shutter button halfway. This cannot be done after the shutter button is pressed halfway.

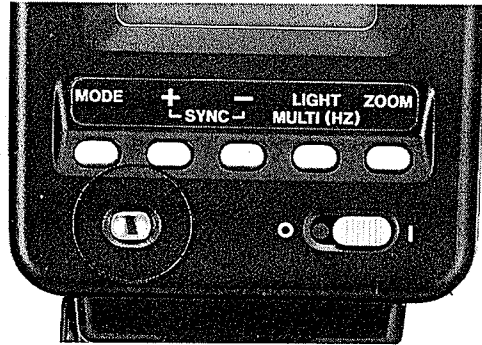

## Rapid-Fire Flash Capability

The Speedlite 430EZ has a rapid-fire capability to help capture an unexpected moment in flash photography. When charged, the color of the ready lamp changes as follows: ①

**Yellow-green:** The unit is in rapid-fire flash status.  
**Red:** The unit is fully-charged.

- See the guide number table for rapid-fire flash status on P. 77.
- Replace the batteries if the ready lamp does not turn yellow-green within 10 seconds after the main switch is turned ON.
- In continuous flash shooting, the exposure is set at the first frame.
- The rapid-fire flash cannot be used in the following conditions.
  - When the film wind mode is set to "C" (continuous shooting).
  - When the camera's shooting mode is set to manual 1/1 or 1/2.
  - When the flash is set to the manual flash mode (See P. 53.)
  - When stroboscopic-flash is done at 6-10 Hz. (See P. 57.)
  - When the external power supply is attached.

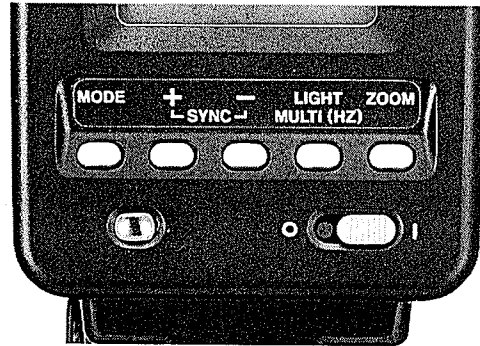

## SE (Save Energy) Function

The 430EZ has a Save-Energy (SE) function that automatically turns off the power when the flash is not used for approximately 90 seconds. ①

Press the shutter button halfway to recharge the flash.

①

- A small current flows when the SE function operates. **Turn the main switch OFF ("O" mark) when finished to prevent unnecessary battery consumption.**
- When the Technical Back E is used for interval or self-timer photography, the flash's power supply turns ON automatically one minute before the set operation.

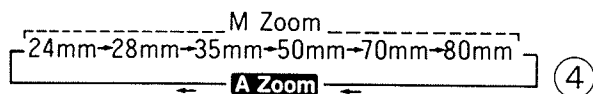
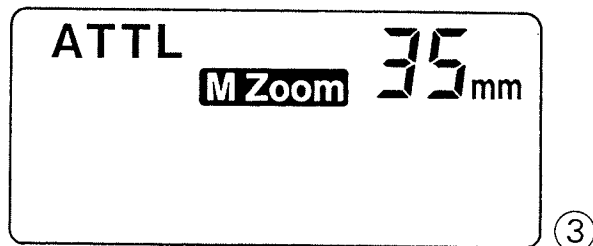
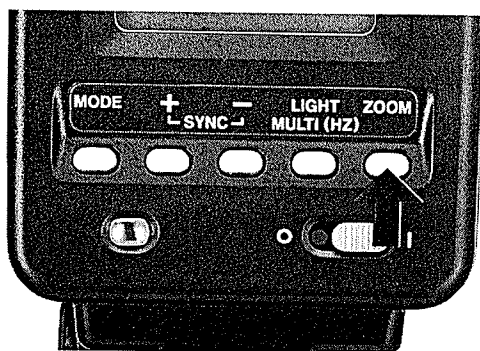
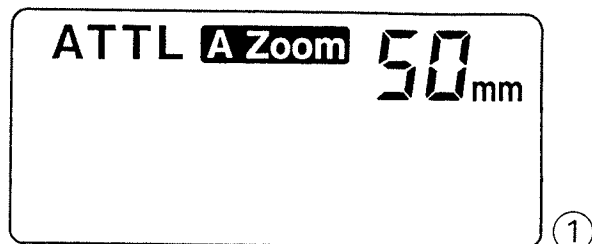

## Auto Internal Zoom Mechanism

### • Automatic Setting

Turn the main switch on ("I" mark). When the shutter button is pressed halfway, the flash head position automatically adjusts according to the lens focal length. The position setting and "A Zoom" appear in the display panel. ①

### • Manual Setting

To change the flash head position manually, press the zoom button until the desired setting appears. ② ③

Each time the zoom button is pressed, the display changes as shown in the following figure. ④

- The amount of illumination changes with the head position. See page 77 for an explanation of the relationship between the illumination range and quantity.
- Be careful not to set a flash head position larger than the lens focal length, or the edges of the picture will become dark.
- When resetting the automatic zoom from the manual mode, press the zoom button and "A Zoom" appears.

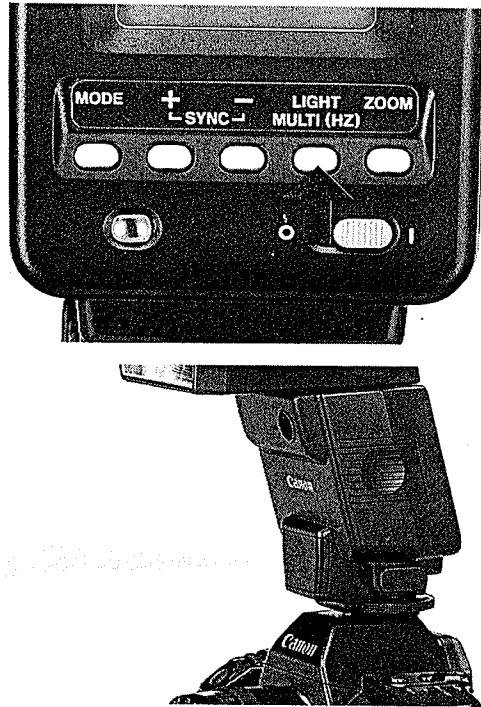

## Film Speed Setting

The film speed is set automatically by the camera.

## Display Panel Illumination

Press the light button to illuminate the display panel for approximately eight seconds in dark conditions. If the light button is pressed again during the initial illumination, the panel glows another eight seconds from the time the button is pressed. ①

## AF Auxiliary Light

In dark settings that are difficult for autofocusing, the AF auxiliary light automatically emits to facilitate focus. The effective distance range is approximately 3 to 32.8 ft. (0.9 - 10 m.) If the subject is too far away, the AF in-focus indicator blinks. Move closer to the subject ②

## Mode Memory Function

This function automatically memorizes the mode and set value before the flash is turned off. This eliminates the need for resetting.

## Basic Operation

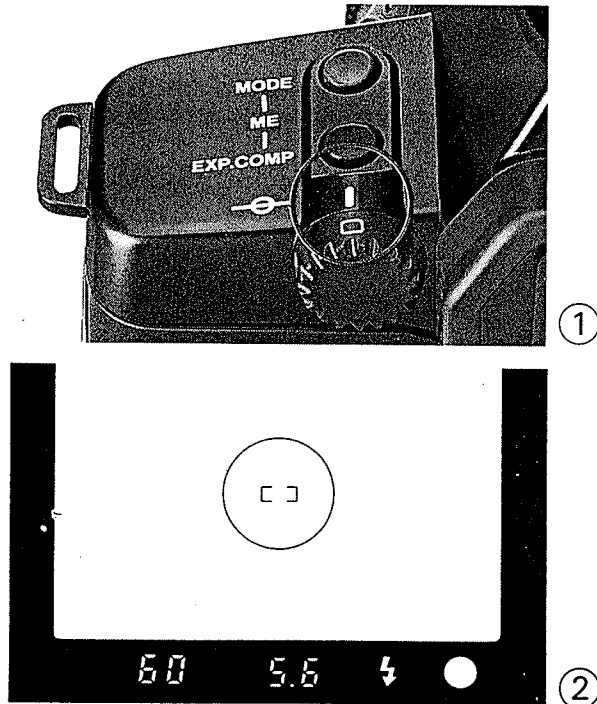

Follow these steps for regular flash photos. These settings will correspond to illumination conditions ranging from total darkness to fill-in lighting.

1. Set the camera's main switch to the full auto position. This is the green  mark on the EOS 620, 630 and 650 and PROGRAM on the selector dial for the EOS 750 and 850. ①
  - When the EOS-1 is used, set the shooting mode to "Program" and the flash to ATTL.
2. Cover the main subject with the AF frame and press the shutter button halfway.
  - The infrared light emits from the flash to determine the appropriate aperture value.
  - The X-sync shutter speed is automatically set from 1/60 sec. to 1/250 sec. for the EOS-1 and 620. For the 630, 650, 750, and 850, 1/60 sec. to 1/125 sec.
3. Press the shutter button completely if the shutter speed, aperture value, and "⚡" mark are not blinking. If these displays blink, check the exposure warnings. ②

### Exposure Warning

## The shutter speed and the aperture values blink.

If both values in the viewfinder are blinking, the camera is warning that the subject is too far away. Move closer to the subject until both values remain continuously lit when the shutter button is pressed again.

- After the flash is fully charged the values may stop blinking when the shutter button is pressed halfway again.
- In fill-in flash, the minimum aperture of the lens in use may blink ("P" will blink in the EOS 750 and 850). The background will be overexposed, but the main subject will be exposed correctly.



①



②

## Flash photos in bright settings

When taking pictures of people against bright backgrounds, the exposure may be unsatisfactory for the main subject will appear dark. To compensate for the large differences in the brightness between the main subject and background, use fill-in flash for even illumination.

The flash reduces the exposure level to prevent unbalanced effects between the brightness of the main subject and the existing light in the background.

- ① With fill-in flash
- ② Without fill-in flash



## Other Operations

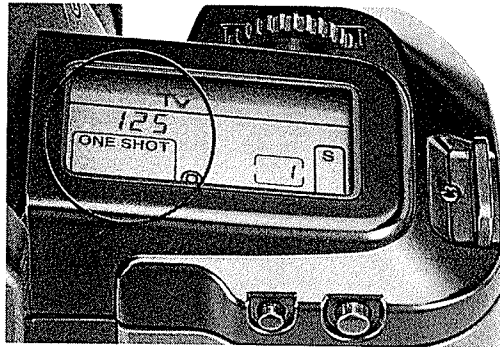

①



②

The Speedlite 430EZ can be used for a variety of photos when combined with other shooting modes.

- Try these variations by using different combinations of shutter speed and aperture settings. Refer to the camera's instruction book for more detailed explanations of these functions.

### Shutter-Priority (TV) Shooting

Set the camera to the shutter-priority mode (TV). The shutter speed can be set between 30 sec. and 1/250 sec. for the EOS-1 and 620, (30 sec. and 1/125 sec. for the 630 and 650).

- **This setting cannot be used with the EOS 750 and 850.**

1. Set the camera's shooting mode to "Tv" and turn the electronic dial to set the shutter speed from 1/250 (\*1/125) to 30 seconds. ①

\* For the EOS 630 and 650

2. Look in the viewfinder and put the AF frame over the subject. ②

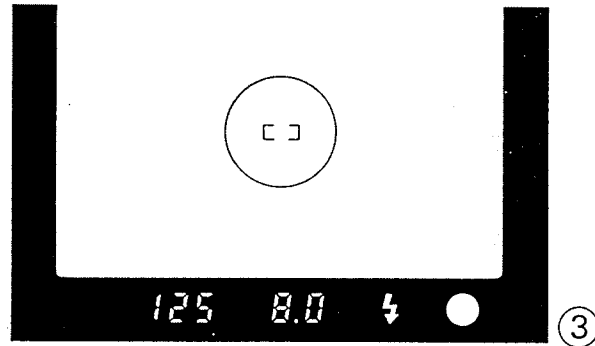

3. When the shutter button is pressed halfway, a preflash fires so that the necessary aperture is set. The shutter speed and aperture value appear in the viewfinder. ③
4. Make sure the “⚡” mark, shutter speed, and aperture value light continuously in the viewfinder, then press the shutter button all the way. If the display values blink, follow the exposure warnings in page 37.

- If a shutter speed faster than 1/250 (\*1/125) is set, it is automatically reset down to 1/250 (\*1/125). Be careful if the shutter speed is set to less than 1/60 sec. as camera-shake is likely to ruin the picture.

\* EOS 630 and 650.

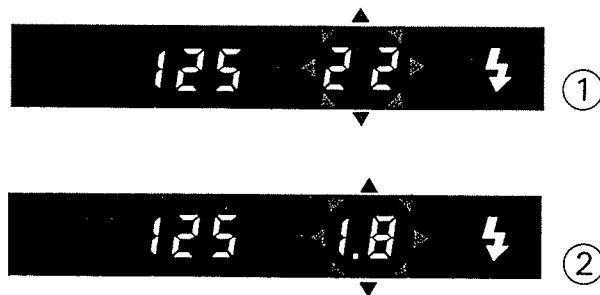

### Exposure Warning

## The shutter speed and aperture values blink.

If both values in the viewfinder are blinking, the camera is warning that the subject is too far away. Move closer to the subject until the shutter speed lights up steadily when the shutter button is pressed again.

## The aperture value blinks.

This warning indicates that the background is overexposed (the minimum aperture value blinks) or underexposed (the open aperture value blinks).

### ① (Minimum aperture value f/22)

The main subject is exposed correctly but the background is overexposed.

### ② (Minimum aperture value f/1.8)

The main subject is exposed correctly but the background is underexposed.

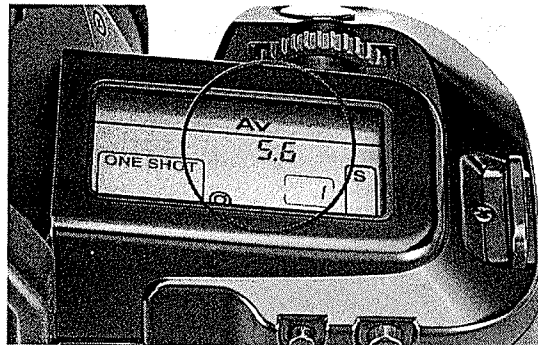

①



②



③

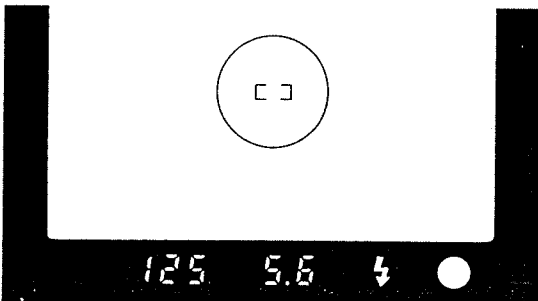

④

## Aperture-Priority (AV) Shooting

Set the camera to the aperture-priority mode (Av). This setting takes the subject depth of field into account and is best for fill-in flash portraits and slow-sync photography. The aperture is set manually and the shutter speed automatically.

- **This feature cannot be used when mounted on the EOS 750 or 850.**
1. Set the camera to "Av" and turn the electronic dial to set the aperture value. ①
    - When "ATTL" is not displayed in the flash, press the mode button until "ATTL" appears.
  2. Cover the main subject with the AF frame. ②
  3. When the shutter button is pressed halfway, a preflash fires, so that the necessary shutter speed is set. The aperture value and shutter speed appear in the viewfinder. ③
  4. Make sure the "⚡" mark, shutter speed and aperture value light up steadily in the viewfinder, then press the shutter button completely. ④
    - Be careful if the shutter speed is set to less than 1/60 sec. as camera-shake is likely to ruin the picture.



## Exposure Warnings

### The shutter speed and aperture values blink.

If both values in the viewfinder are blinking, the camera is warning that the subject is too far away. Move closer to the subject until the aperture value lights up steadily when the shutter button is pressed again. Wait until the ready lamp turns red before pressing the shutter button.

### The shutter speed blinks

This indicates that the background is overexposed (1/250 (\* 1/125) blinks) or underexposed ("30" blinks). The main subject will be exposed correctly but the background will not be.

\* EOS 630 and 650.

- ① Background overexposed
- ② Background underexposed



①



②

## Slow-Sync Shooting

If the flash is used to illuminate the subject in dark backgrounds, the background will be dark because the exposure is insufficient.

In this case, set the shooting mode to AV (aperture priority) and select an aperture value. The shutter speed will be set automatically ensuring that the background will be exposed correctly.

- This function cannot be used when the main switch is set to the green  mark or P.
- This function cannot be used with the EOS 750 or 850.
- In slow-sync shooting, use a tripod to minimize camera-shake from the slow shutter speeds.

① Slow-sync flash

② Normal flash

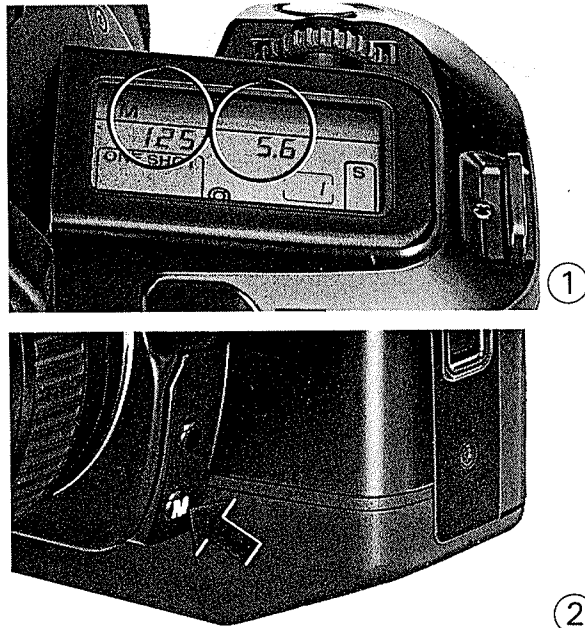

## Manual Mode

The advantage of the TTL auto flash system is that you can select the shutter speed and the aperture value as desired.

- The manual settings cannot be done when mounted on the EOS 750 and 850.
- 1. Set the camera to the M (manual) mode, and then set the shutter speed and aperture value. ① ②
  - If the shutter speed is set faster than 1/250 (\*1/125), it is automatically set down to 1/250 (\*1/125).
  - \* EOS 630 and 650.
- 2. Cover the subject with the AF frame.
- 3. Press the shutter button halfway and the flash coupling range will appear ⑤ in the flash display panel. ③

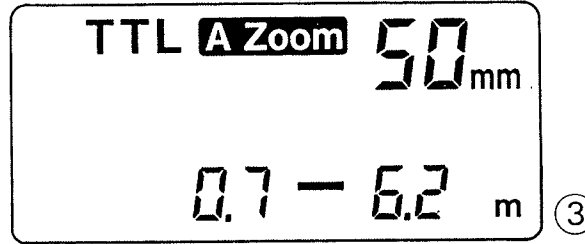
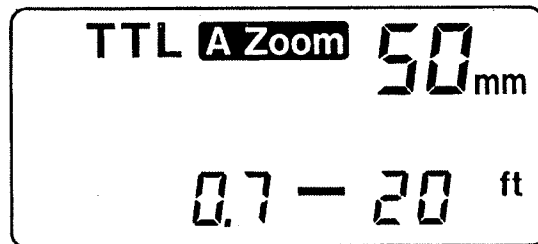

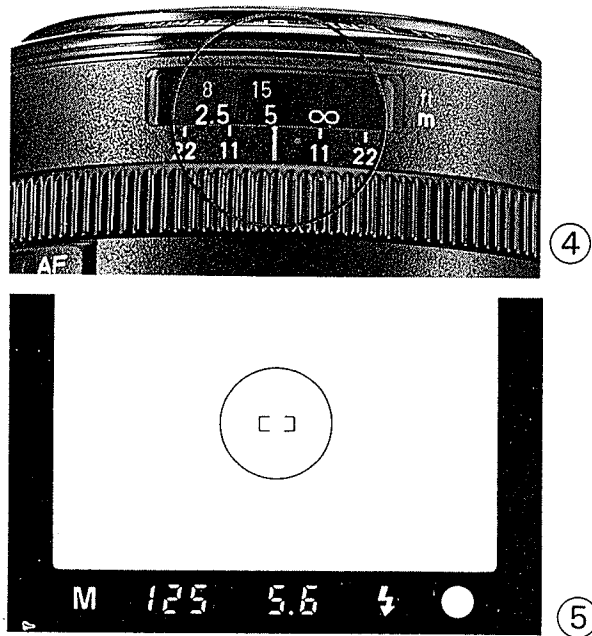

4. Focus the subject. Press the shutter button halfway to check that the shooting distance indicated in the distance scale window is within the flash coupling range. ④
5. Make sure that the “⚡” mark in the viewfinder appears and then press the shutter button.

- Shooting is not possible when the flash shooting distance blinks in the flash display panel. When the shooting distance range is beyond 99ft/30m, “▶” mark appears. ⑤
- When setting the shutter speed and aperture value manually, the TTL mode is set automatically even if the ATTL mode was previously set. The illumination is set so the main subject is exposed correctly. The rapid-fire function cannot be used in the manual mode.



## Advanced Shooting Techniques

This section covers special techniques such as exposure compensation, stroboscopic flash, and bounce flash for photos with a professional look. Although the correct exposure is generally set for the TTL automatic flash, sometimes it may not be suitable in the following cases:

- ① The main subject is small and the background is dark or distant.
- ② The subject's surroundings are a bright white.

If fill-in ratio control and manual flash are used with the 430EZ, the proper exposure can be obtained under these kind of difficult conditions.

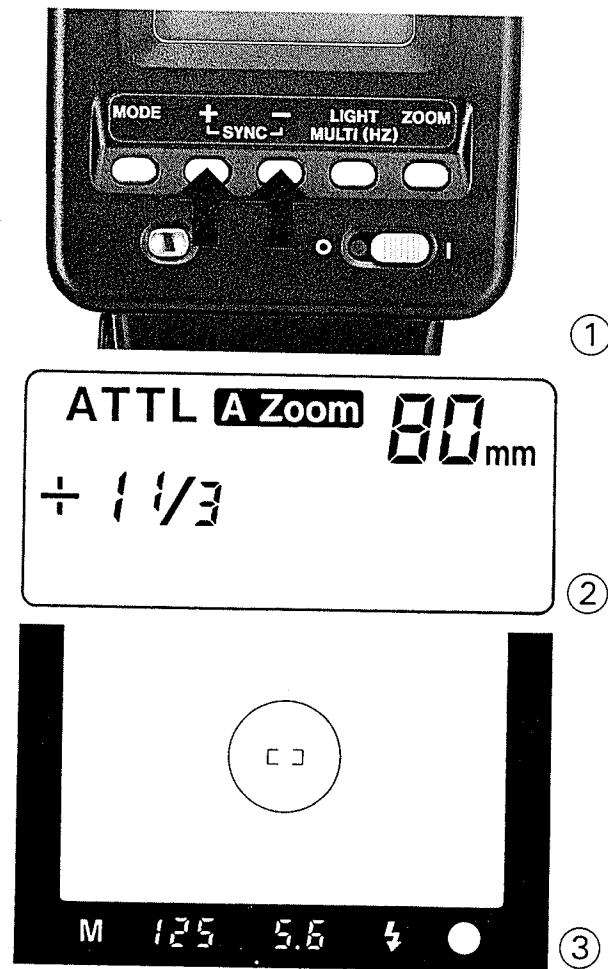

## Fill-in Ratio Control

(EOS-1 and 630 only)

Previously, exposure compensation could only be set on the camera, however, the 430EZ allows flash exposure compensation (fill-in ratio control) setting in 1/3 increments from +3 to -3.

- This control can only be done in the following modes.
  - Program AE
  - Shutter-priority AE
  - Aperture-priority AE
  - Manual
- Set the flash to ATTL (TTL in manual).
- Press the plus and minus (+ and -) buttons to set the control level. ① ②
- Make sure that the shutter speed, aperture value and "⚡" light and then press the shutter button completely. ③
  - This function cannot be performed on the EOS 630 if the camera is set to the green  mark.
  - The amount of control appears in the viewfinder of the EOS-1 but not in the EOS 630.

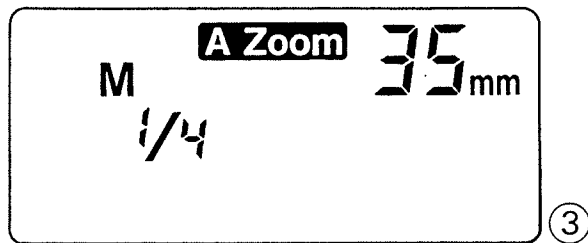
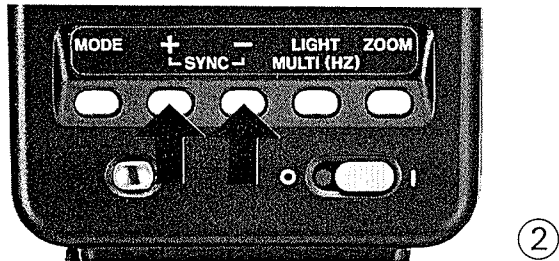
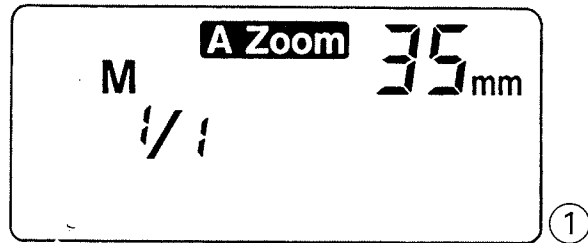

MI/1=MI/2=MI/4=MI/8=MI/16=MI/32 ④

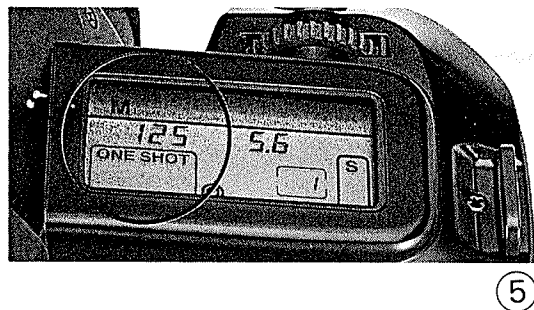

## Manual Flash Shooting

An ordinary, manual flash relies on troublesome guide number calculations. However, manual flash with the 430EZ performs these calculations automatically. Make sure the camera is set to Manual.

- This function cannot be done when mounted on the EOS 750 or 850.

The 430EZ adjusts the flash intensity within six levels, from full flash to 1/32 flash.

1. Press the mode button to display M1/1 which indicates the manual flash mode. ①
2. Press the plus and minus (+ and -) buttons to set the flash intensity. ② ③ ④
3. Set the camera to M (manual mode) and then set the shutter speed and the aperture value. If the shutter speed is set faster than 1/250 sec. (\*1/125), it is automatically set down to 1/250 sec. (\*1/125). ⑤ ⑥

\* EOS 630 and 650

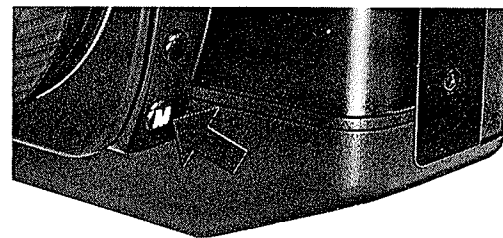

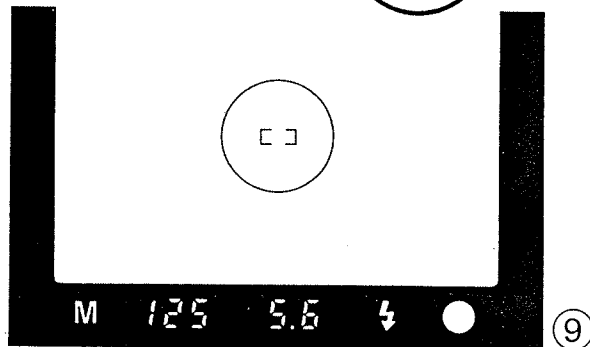
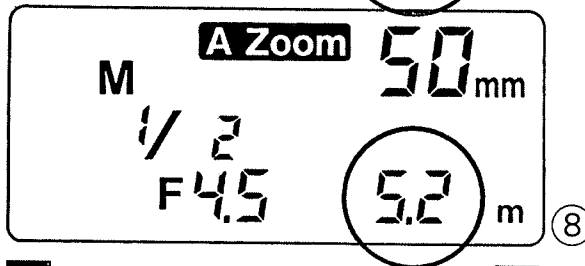
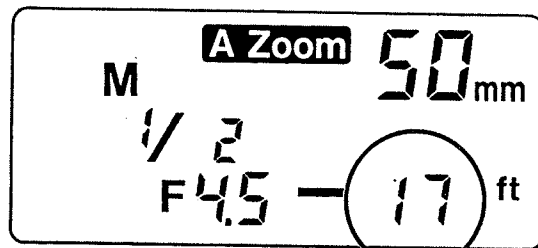
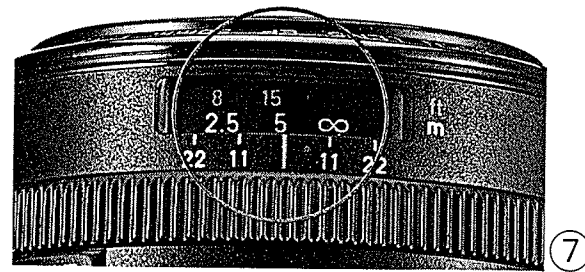

4. Press the shutter button halfway to focus the subject.

Read the lens distance scale or make a visual measurement and compare this with the displayed flash coupling range. ⑦ ⑧

Shooting is possible when the flash coupling range nearly equals the lens distance. Perform the following procedures if there is a large difference.

- ① As the aperture distance changes, the flash coupling range adjusts until it is about the same as the actual shooting distance.
- ② As the flash intensity changes, the flash coupling range adjusts so it is about the same as the actual shooting distance.

5. Make sure the “⚡” mark lights and then press the shutter button completely. ⑨

- Rapid-fire capability can not be performed when M1/1 or M1/2 is set.

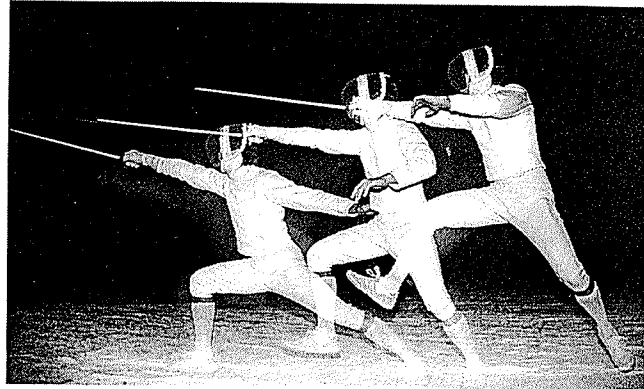

## Stroboscopic Flash

When manual flash is used, it is possible to shoot continuous motion for a flowing effect in the photo. Set the flash intensity within the range of 1/4 to 1/32, and then select the value from one to ten for the number of flashes per second.

The relation between the flash intensity and the number of flashes per second is shown in the chart below.

Be sure to use new or freshly charged batteries.

- The stroboscopic flash stops after twenty consecutive flashes.
- This function cannot be done with the EOS 750 or 850.

1. Set the camera to "M" (manual mode). Set the desired aperture and shutter speed. ① ②
  - The shooting distance increases as the aperture opens.
  - Set the shutter speed to cover all the subject's motion.
2. Press the mode button so [MULTI 1Hz] and "M 1/16" appear in the display panel to indicate the manual flash mode. ③

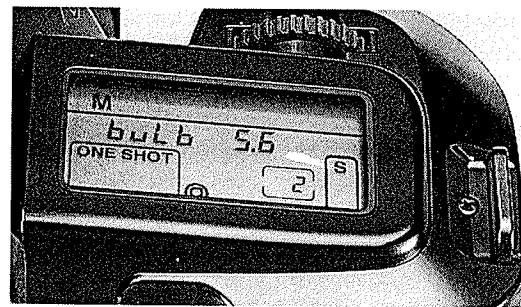

①

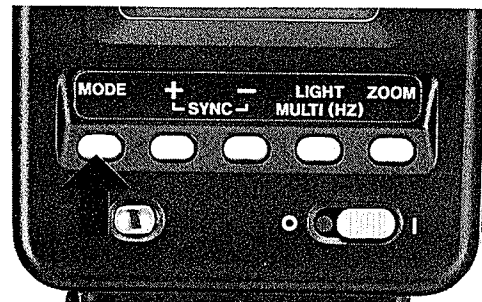

②

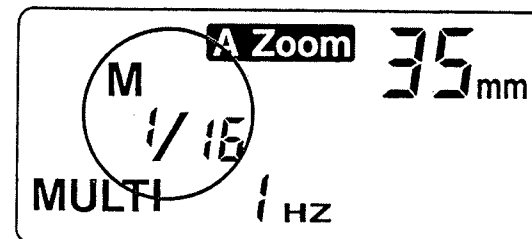

③

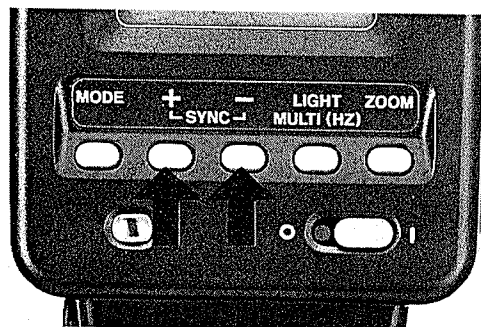

M1/4 → M1/8 → M1/16 → M1/32

④

⑤

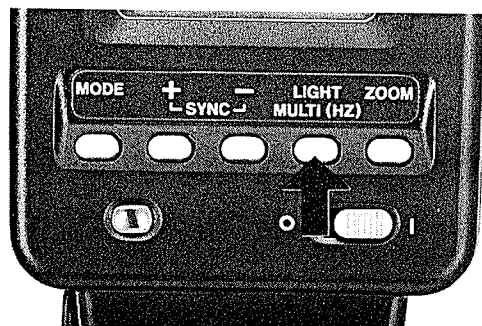

1Hz → 2Hz → 3Hz → ..... 8Hz → 9Hz → 10Hz

⑥

⑦

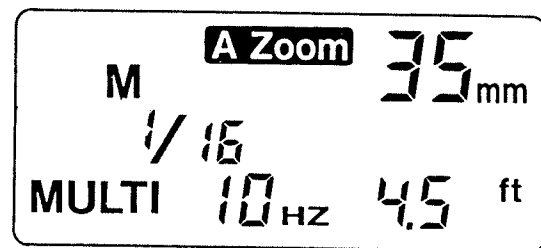
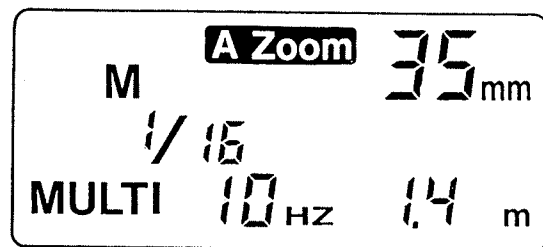

⑧

3. Press the plus and minus buttons (+ and -) to set the flash intensity. ④ ⑤
  - The M1/1 and M1/2 settings cannot be used in stroboscopic flash.
4. Press the multi-flash button to set the number of flashes per second. ⑥ ⑦
5. After the ready lamp turns red, press the shutter button halfway.
6. Use the flash coupling range displayed in the flash panel for the shooting. ⑧
  - The yellow-green ready lamp does not light between 6 kHz - 10 kHz.
  - This mode is effective when the main subject is highly reflective and the background is as dark and distant as possible.
  - Due to slow shutter speeds in this mode, use a tripod to minimize camera shake.
  - The Canon Remote Switch 60T3 is recommended for this mode.

### Maximum Number of Flashes

(number of flashes until the ready lamp goes out)

Number of Times	Flash Intensity	M1/4	1/8	1/16	1/32
	10Hz		3	5	9
9Hz		3	5	9	13
8Hz		3	5	9	13
7Hz		3	5	9	13
6Hz		3	5	9	14
5Hz		4	8	17	20
4Hz		4	8	18	20
3Hz		4	9	20	20
2Hz		5	9	20	20
1Hz		5	12	20	20

\* Data based on use of new, three, AA-size batteries

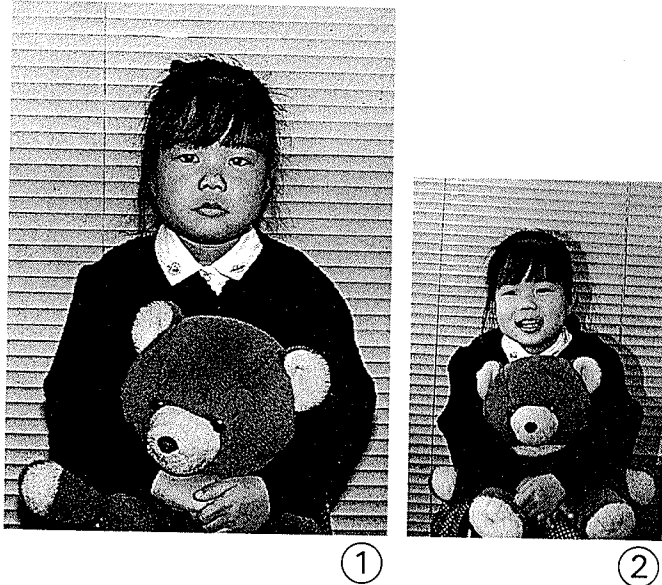

## Bounce Flash Photography

Bounce flash illuminates the subject by pointing the flash head toward a wall or ceiling. Because the light is reflected, a loss of light volume is unavoidable, but on the other hand, there are no dark shadows and a soft illumination.

The Speedlite 430EZ features ATTL automatic output control so there is no need for exposure calculations.

1. Set the camera to any mode except "M".
  - Bounce flash photography can be performed in the M (manual) mode but calculations are necessary to determine the flash coupling range.
  - When the shutter button is pressed halfway during bounce photography, a preflash emits from the flash head to determine the shutter speed or the aperture value to obtain the best possible exposure.
  - The actual shooting distance is determined by the total of the flash-to-reflecting surface distance and the subject-to-reflecting surface distance. Be careful not to go beyond the flash coupling range. In this case, the shutter speed and aperture value flash simultaneously.

- ① With bounce flash
- ② Without bounce flash



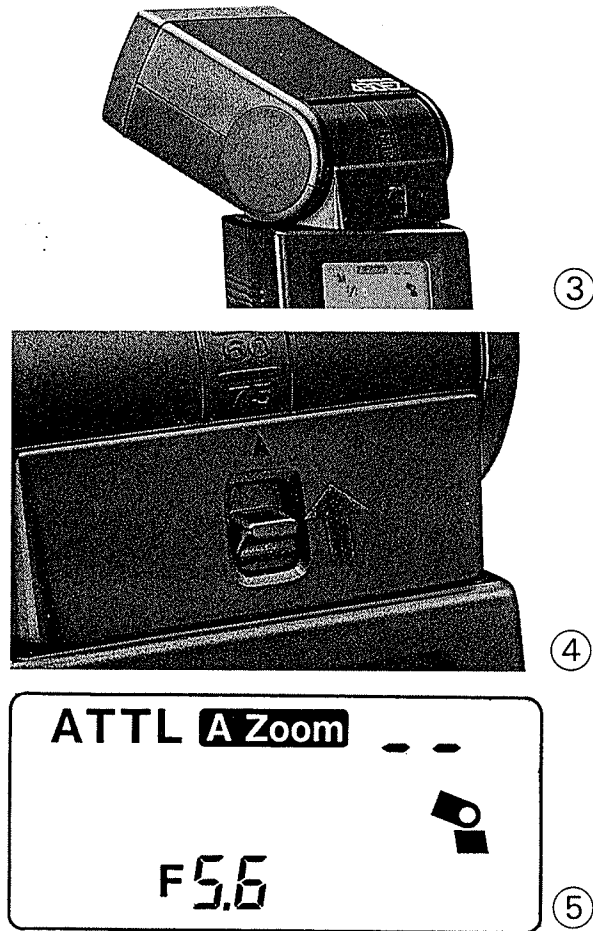

2. Point the flash head towards a wall or ceiling that will reflect the light. The flash head swivels upwards and horizontally and can be used in various positions. It swivels 90° upward, 180° to the left and 90° to the right in any combination. Move the flash horizontally to the desired position while pressing the bounce latch upward. The bounce mark (  ) appears in the display panel when bounce photography is performed. ③ ④

⑤

- The flash angle is automatically set to 50 mm for bounce photography. This is not displayed on the flash panel. It is also possible to set the flash head position manually.

3. When the ready lamp glows, press the shutter button halfway.

4. After making sure the shutter speed and aperture value glow continuously, press the shutter button all the way.

- In bounce flash photography, it is necessary to adjust the flash head so that the subject is not directly illuminated by the flash.

- The bounce surface should be white or nearly white and highly reflective. A colored reflecting surface may cause the subject to appear tinted in that color. For color photography, make sure that the reflective surface color is correct and that no undesired color is being reflected.

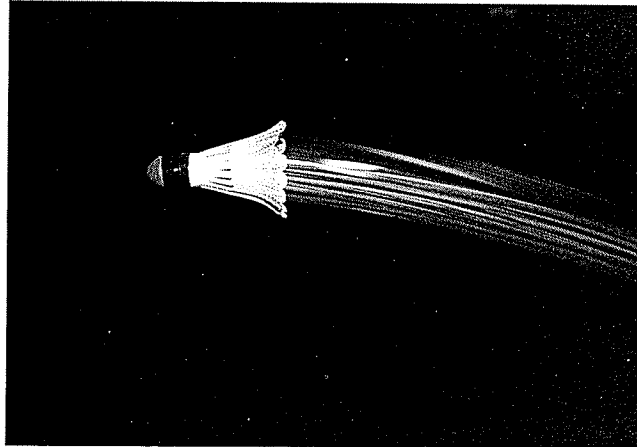

①

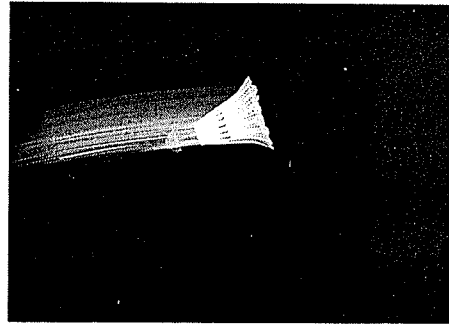



②

## Second-Curtain Sync Photography

With focal plane shutters, flash synchronization is made when the first curtain is fully open. With the combination of the EOS and the 430EZ Speedlite, it is also possible to perform flash synchronization just before the second curtain starts running. This is called "second-curtain sync" and is effective for expressing motion through a trailing light.

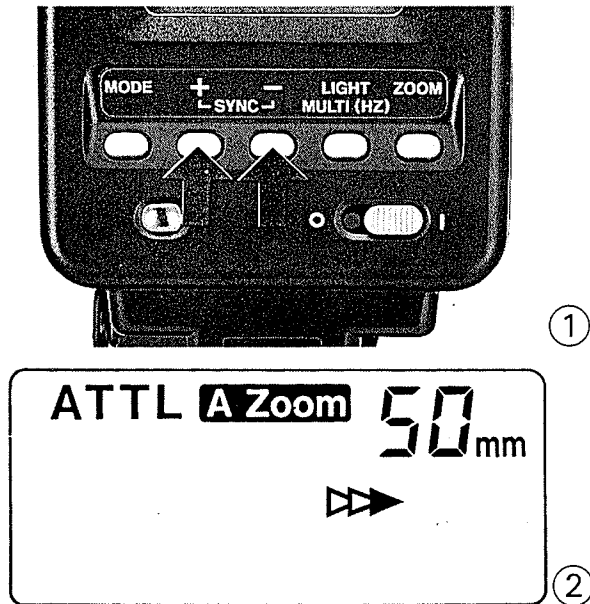
- ① Second-Curtain Sync
- ② First-Curtain Sync



Press the plus and minus buttons simultaneously to display the second-curtain sync mark (  ) on the panel. ① ②

Press the buttons again simultaneously to cancel the second-curtain flash.

- The second-curtain sync cannot be used with the EOS 750 and 850.
- Second-curtain sync is facilitated by setting the camera to BULB.
- If the camera is set to the green mark  (620, 630, 650), first-curtain sync is set automatically and second-curtain sync cannot be used.
- The second-curtain sync cannot be used with stroboscopic flash.

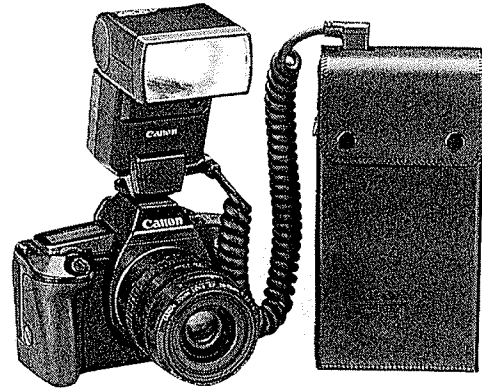

## External Power Supply

The 430EZ can be used with two types of external power supplies.

### Transistor Pack E

- ① Uses Six, C-size batteries
- ② Use the Canon Ni-Cd Pack TP

An external power supply reduces the flash recharge time for faster output and increases the number of flashes.

## Slave Unit

Slave units for multiple flash photography are attachable, but make sure it can be properly used with the 430EZ before purchase.

## Off-Camera Flash Photography

The 430EZ can be used off-camera to produce very professional results. With the proper accessories, light from all off-camera flash units is metered through the lens. It is not necessary to make exposure calculations unless you set the flash manually. The following accessories can be used for multiple flash photography with the 430EZ, 420EZ, 300EZ, Macro Ring Lite ML-2/ML-3 and 300TL.

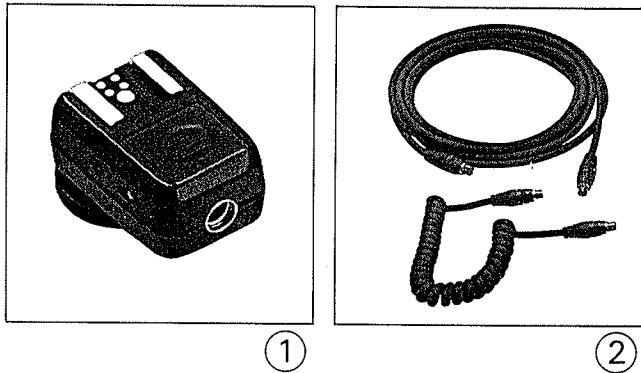

- ① **TTL Hot Shoe Adapter 2**  
Attaches to the camera's accessory shoe. One lithium battery (CR-2025) is required for operation.  
Note: The TTL Hot Shoe Adapter 2 is designed for use on the EOS models.
- ② **Connecting Cords 60 and 300**  
Used to connect various multiple flash accessories. Connecting Cord 60 is 2ft. (60 cm) in length, while Connecting Cord 300 is 9.8 ft. (3 m) long.



③

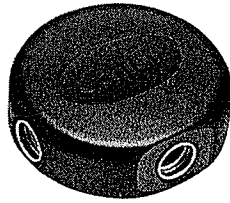

④

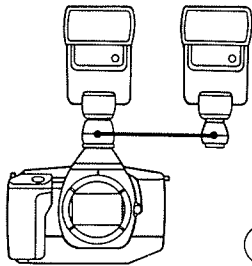

⑤

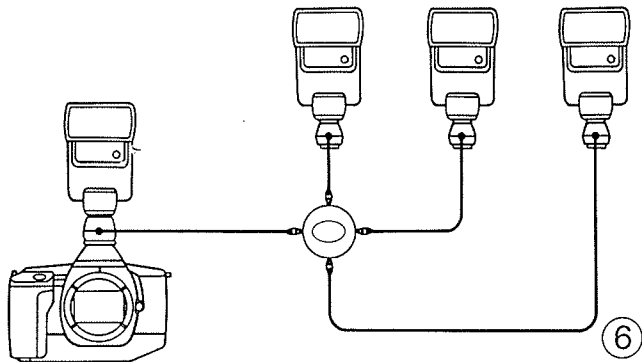

⑥

### ③ Off-Camera Shoe Adapter

Attaches to the flash unit's directly coupled contact, and is connected to the TTL Hot Shoe Adapter by means of Connecting Cord 60 or 300. This item contains a tripod socket.

### ④ TTL Distributor

Used when the flash units are positioned away from the camera and when three or four units are used simultaneously for multiple flash photography.

Multiple Flash Photography

### Disabled Features

Certain features are disabled when using the 430EZ off-camera.

- (1) ATTL Mode (TTL autoflash is used)
- (2) Preflash
- (3) Second-Curtain Synch
- (4) The EOS "DEPTH" Mode cannot be used.
- (5) EOS-1, 620630's Program Shift does not function.
- (6) The 430EZ's Internal Zoom (can be set manually)
- (7) 430EZ's aperture value and coupling range are not displayed.
- (8) AF Auxiliary light is not projected.

## Specifications

### Type:

Energy-saving, automatic, electronic flash unit  
 ATTL metering system to measure light reflected  
 from the film surface. Clip-on type with directly  
 coupled contacts. For exclusive use with EOS  
 cameras.

### Guide Number Table (at ISO 100):

Zoom position (mm)	24	28	35	50	70	80	
Normal flash	25	27	30	35	40	43	
Rapid-fire flash	1/2 to 1/16 of that for normal flash						
Manual Flash	1/1	25	27	30	35	40	43
	1/2	17.7	19.1	21.2	24.7	28.3	30.4
	1/4	12.5	13.5	15	17.5	20	21.5
	1/8	8.8	9.5	10.6	12.4	14.1	15.2
	1/16	6.3	6.8	7.5	8.8	10	10.8
	1/32	4.4	4.8	5.3	6.2	7.1	7.6

### Number of Flashes:

	Power supply AA-size (alkaline battery)	Power supply AA-Size (Ni-Cd)
Normal Flash	Approx. 100 to 700	Approx. 45 to 300

\* The numbers on the right are for the ATTL mode, and the numbers on the left side are for the manual (1/1) flash. The manual 1/2, 1/4, 1/8, 1/16 and 1/32 number of flashes are 2, 4, 8, 10 and 12 times the full flash (1/1) value.

### Recycling Time

Flash Mode	Power supply AA-size (alkaline battery)	Power supply AA-Size (Ni-Cd)
Normal Flash	Approx. 0.2 - 13 sec.	Approx. 0.2 - 6.5 sec.
Rapid-fire flash	Approx. 0.2 - 1.5 sec.	Approx. 0.2 - 1.0 sec.

\* The numbers on the right are for the ATTL mode, and the numbers on the left side are for the manual (1/1) flash.

### External Power Supply

	C-size batteries	Ni-Cd Pack TP
Normal flash	0.2 - 8 sec.	0.2 - 2 sec.

### Flash Duration:

1.5 ms or less

### Flash Coverage Angle:

Covers more than the fields of view of 24 mm, 28 mm, 35 mm, 50 mm, 70 mm and 80 mm using an auto internal zoom mechanism. Manual switchover is also possible.

### Bounce Angle:

Upward: 0-90°, Left: 0-180°, right: 0-90°  
The flash emits a preflash for bounce flash.



**Flash Exposure Level Control:**

ATTL automatic flash, TTL automatic flash (when the camera is set in the manual mode), manual

**Flash Control System:**

TTL control system with film surface illumination

**Flash level Control:**

- (1) Automatic - Daylight syncro reduction control preset
- (2) Manual - Manual correction within +/- 3 levels in 1/3 level steps (except when the camera is in the full-automatic mode)

**X-Sync Shutter Speed**

Shutter-Priority AE	1/250 (1/125) or less for manual, otherwise automatically set to 1/250 (1/125) when faster.
Aperture-Priority AE	Automatically set from 1/250 (1/125) to 30 seconds.
Program AE	Automatically set from 1/250 (1/125) to 1/60 seconds.
Manual	Same values as the Shutter-Priority AE

\* The figures in parentheses apply to the EOS 630, 650, 750 and 850.

**Flash Range:**

ATTL normal flash: 2.3 - 62.3 ft 0.7 - 19 m

Rapid-fire flash: 2.3 - 16.4 ft 0.7 - 5 m minimum  
2.3 - 45.9 ft 0.7 - 14 m maximum

\* Based on 50 mm f/1.8, ISO 100

**Out-of-Coupling Range Warning:**

If the subject is too far away, the shutter speed and the aperture value blink in the viewfinder when shutter button pressed halfway.

If the subject is too close, the distance display blinks.

**Ready Lamp:**

The ready lamp turns red when fully charged, the ready lamp turns yellow-green during rapid-charge. The rapid-charge does not light when an external power supply is used.

**Sync Timing:**

Switching between first- and second- curtain timing is possible.

**Power Source:**

Four size-AA (LR6) alkaline or Ni-Cd batteries. Carbon-zinc batteries may also be used.

**External Batteries:**

Transistor Pack TP

- 1) Six C-size alkaline batteries
- 2) Canon Ni-Cd Pack TP

**SE (Save-Energy):**

Power automatically turns off after 90 seconds of non-use when the main switch is left on.

**Other:**

(1) Mode memory function:

Even if the main switch is turned OFF, the last control mode and the zoom position just before the unit is turned off are stored in memory.

(2) When the EOS-1 is used, the distance and aperture value on the display panel correspond to the EOS-1. These values are displayed in 1/3 steps.

**Dimensions: (W × H × D)**

2-15/16" × 5" × 4-3/16"

75 × 122 × 106 mm

**Weight:**

12.7 oz (365 g) without batteries

Subject to change without notice.

All data are based on Canon's Standard Test Method.

INCORPORATING OLDTIMER CAMERAS

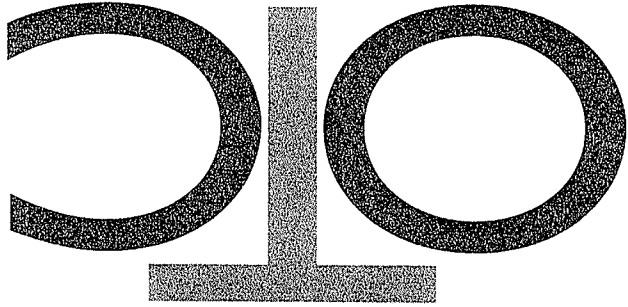

**OTC Ltd**, 24 Market Place, Hatfield, Herts, AL10 0LN

Tel: 01707 273773 Fax: 01707 273774 Email: [sales@otcworld.co.uk](mailto:sales@otcworld.co.uk) [www.otcworld.co.uk](http://www.otcworld.co.uk)